

Unit : mm

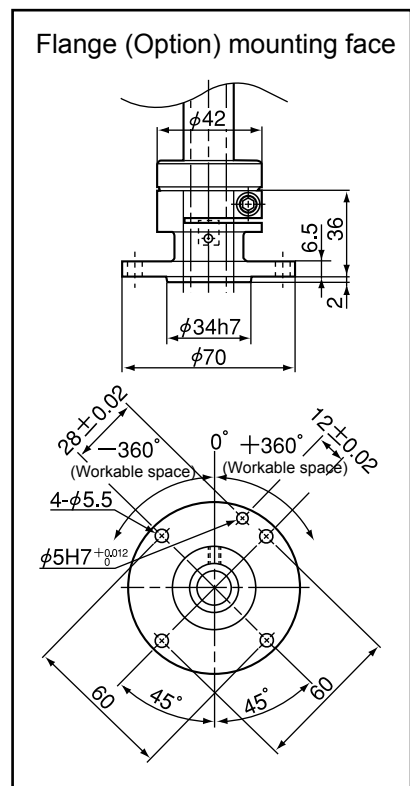
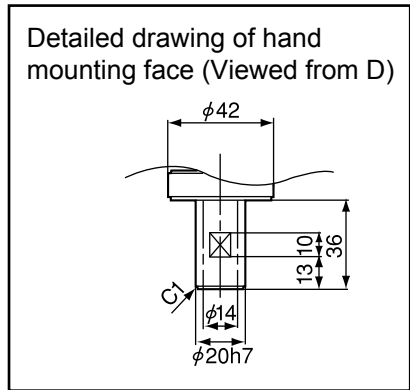
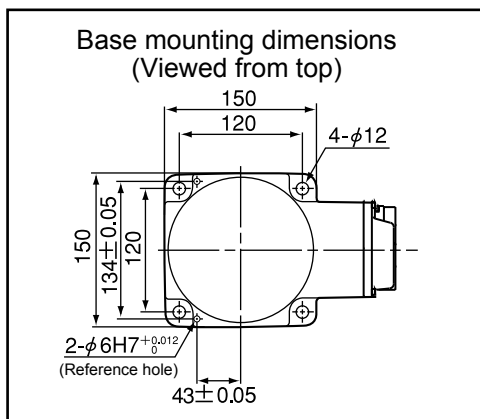

Model	A	B	C
HS-4555*G-UL	550	325	191

Z axis stroke : S(mm)	L1	L2
*=2 : 200	697	46
*=3 : 320	817	-74 (note1)

(1) In case of the Z axis 400mm stroke type, the Z axis in the lowermost position may reach lower than the base mounting face