

运行范围

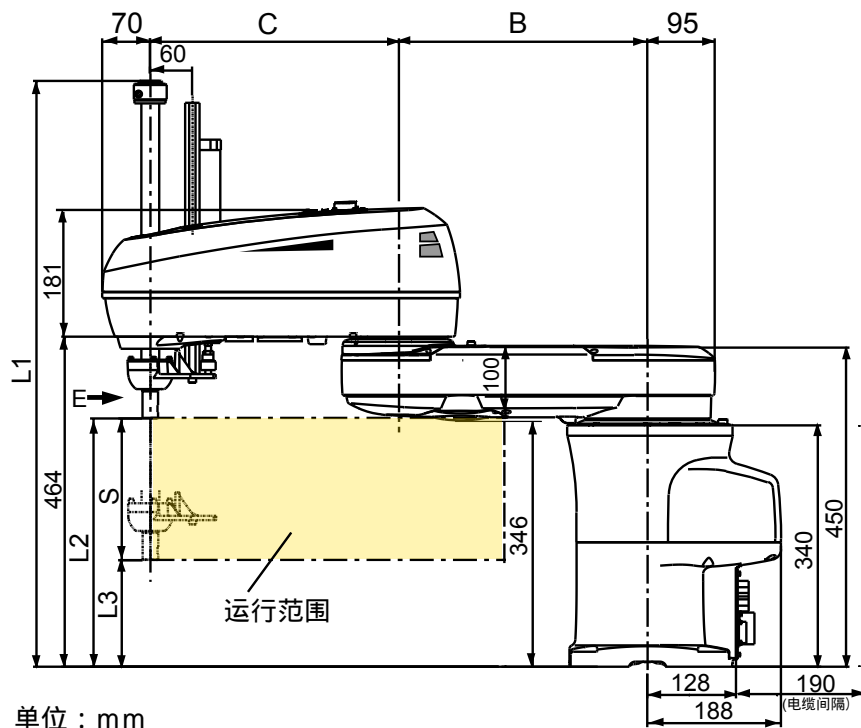

单位：mm

型号	A	B	C	D	F
HM-4A85*G	350	350	500	281	294°

S (Z轴行程)	L1	L2	L3
100	748.7	350	150
150	798.7	350	250
200	849	350	150
300	949	350	50
400(注1)	1049	350	-50

(注1) Z: 400mm的情况下, Z轴的最低下降位置达到低于底座安装面的位置。

