

运行范围

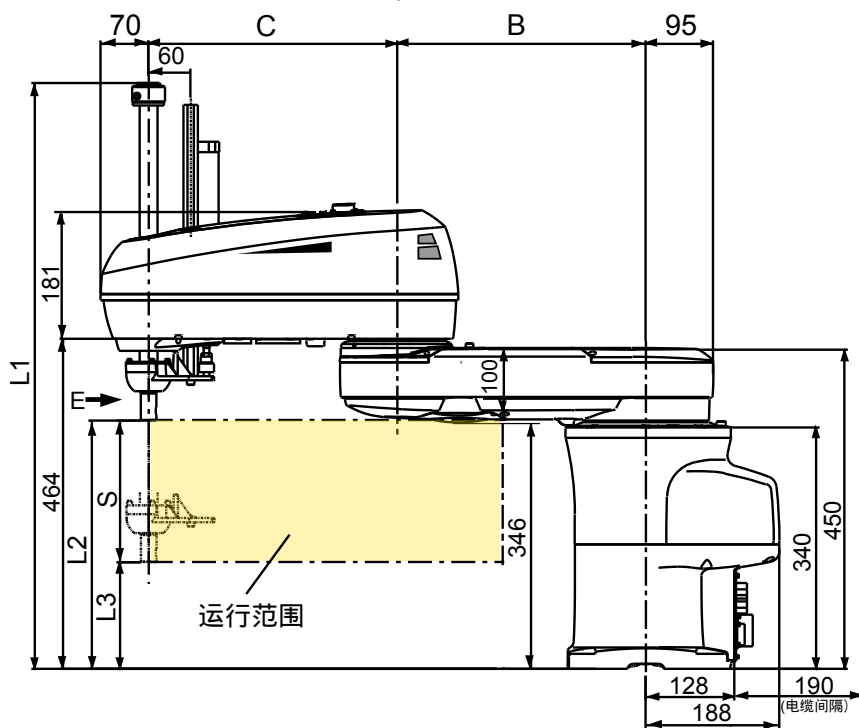

运行范围

型号	A	B	C	D	F
HM-4085*G	850	350	500	281	294°

S (Z轴行程)	L1	L2	L3
100	754.7	350	250
150	804.7	350	250
200	855	350	150
300	955	350	50
400(注1)	1055	350	-50

(注1) Z: 400mm的情况下, Z轴的最低下降位置达到低于底座安装面的位置。

单位: mm

